



## Special Alloys

Maximum Corrosion Resistance



**MaxCore 6Mo**  
**MaxCore 904L**  
**MaxCore Alloy 22**



**NEUMO | VNE | EGMO**

NEUMO Ehrenberg Group



# MaxCore Special Alloys

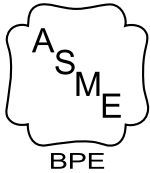

MaxCore Alloy tube and fittings are manufactured in strict compliance with the ASME-BPE Standard.

These products offer improved corrosion resistance for the most aggressive environments in the sanitary and high purity industries.

## Our MaxCore Alloy products proudly offer:

### Corrosion Resistance

MaxCore products contain high percentage molybdenum which increases the resistance to localized corrosion in the forms of pitting and crevice corrosion. The higher the molybdenum content, the better the corrosion resistance to higher chloride levels by enhancing the passive film, making it stronger and helping it to re-form quickly if it is disrupted by chlorides.

### Cleanliness and Packaging

MaxCore Alloy fittings go through a nine step cleaning and process after manufacturing, including passivation in accordance with ASME BPE and ASTM A967 Standards.

Each fitting or tube is then capped with a color coded cap, Orange for electropolished and white for mechanically polished fittings for quick identification prior to being placed into plastic zip locked bags.

Each bag is marked with a QR code for simple MTR download allowing for immediate QA/QC reviews at the job site.

### Full Traceability

We provide full traceability for each of our products by supplying all necessary production process data. Starting from certifications and incoming inspection of raw materials, through in-process quality control, final inspection, marking and packaging. The process is also completely documented with a unique job number for each BPE process component.

### Every Fitting is Quality Inspected

All around quality and meticulous inspection insures that every fitting will be of the highest quality and in total compliance with all ASME BPE standards. MaxCore Alloys fittings are 100% visual inspected.

## Additional High Purity Offerings

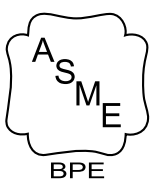

MaxPure ASME BPE is the leading brand for stainless steel fittings used in the pharmaceutical industry.

This series of items are manufactured from 316L stainless steel with a controlled sulfur content of 0.005%-0.017% on weld ends.

MaxPure fittings meet all the strict requirements of the ASME BPE according to the latest edition.

## Index

Fittings Specifications..... 7  
Tube Specifications..... 9  
How to order..... 10  
Ordering Information..... 10

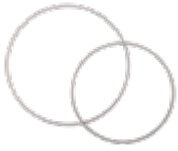

Insert Rings | Page 10 |



Elbows | Page 12-13 |



Tees | Page 14-16 |



Reducers | Page 17-19 |



Ferrules | Page 20 |



Solid End Caps & Weld Caps  
| Page 21 |

Tubes and Fittings..... 11  
Welding..... 22  
General Technical Information..... 23  
Also available..... 24  
MTR - Material Test Report..... 26  
ASME BPE - Certificate..... 27

## Introduction

Corrosion costs the high purity and sanitary industries millions of dollars per year in replacement costs and lost production. For this reason, there is an increasing demand for alloys offering superior corrosion resistance over the traditional 300 series stainless steels.

In high purity and sanitary processing for products such as pharmaceuticals, personal care, and food where high concentrations of chlorides, high processing temperatures and low pH can be found, it has become normal to use corrosion resistant alloys.

The super-austenitic steels classed with the UNS N08367 is one material widely used in applications where chloride induced corrosion is problematic. UNS N08367 materials contain 6% molybdenum which has increased resistance to pitting and crevice corrosion are more commonly known by their trade names MaxCore 6Mo® and Ultra6XN®.

## Alloy Chemical Composition

Type	UNS	Grade	similar EN- (European) Grade	C (max)	N	Cr	Ni	Mo	Cu	Typical trade names
Austenitic	S31603	316L	1.4404	0.03	0.1	16.0-18.0	10.0-14.0	2.0-3.0	-	
Duplex	S32205	2205	1.4462	0.03	0.14-0.20	22.0-23.0	4.5-6.5	2.5-3.5	-	
Superaustenitic	N08904	<b>904L</b>	1.4539	0.02	-	19.0-23.0	23.9-28.0	4.0-5.0	1.0-2.0	<b>MaxCore 904L</b> URANUS B6
Superduplex	S32750	2507	1.4410	0.03	0.24-0.32	24.0-26.0	6.0-8.0	3.0-5.0	0.5	
Superaustenitic	S31254	SMO254	1.4547	0.02	0.18-0.22	19.5-20.5	17.5-18.5	6.0-6.5	0.5-1.0	
Superaustenitic	<b>N08367</b>	<b>6Mo</b>	<b>1.4529</b>	0.03	0.18-0.25	20.0-22.0	23.5-25.5	6.0-7.0	0.75	<b>MaxCore 6Mo</b> Ultra 6XN® AL-6XN®
Superaustenitic	N08926	6Mo	1.4529	0.02	0.15-0.25	19.0-21.0	24.0-26.0	6.0-7.0	0.5-1.5	Ultra 6XN® Alloy 926
Nickel Base	N10276	Alloy C276	2.4819	0.01	-	16	57	16	0.5	Hastelloy C276®
Nickel Base	N06022	<b>Alloy 22</b>	2.4602	0.01	-	22	56	13	0.5	<b>MaxCore Alloy22</b> Hastelloy C22®

The Unified Numbering System for Metals and Alloys (UNS) provides a means of correlating many internationally used metal and alloy numbering systems administered by societies, trade associations, and individual users and producers of metals and alloys. Jointly developed by SAE International and ASTM International, it provides the uniformity necessary for efficient indexing, record keeping, data storage and retrieval, and cross-referencing.



The desired pitting corrosion resistance of weldments of MaxCore 6Mo (UNS#N08367) alloy can be achieved by selecting filler metals having Pitting Resistance Equivalent Number (PREN) values at least ten times higher than the base metal regardless of the type of arc welding process (see Figure 2). The higher the number, the better the corrosion resistance.

$$\text{PREN} = \% \text{Cr} + 3.3\% \text{Mo} + 30\% \text{N}$$

If these filler metals are used, the weldment will have pitting and crevice corrosion resistance about equal to that of the parent metal.

### PREN - Pitting Resistance Equivalent Number

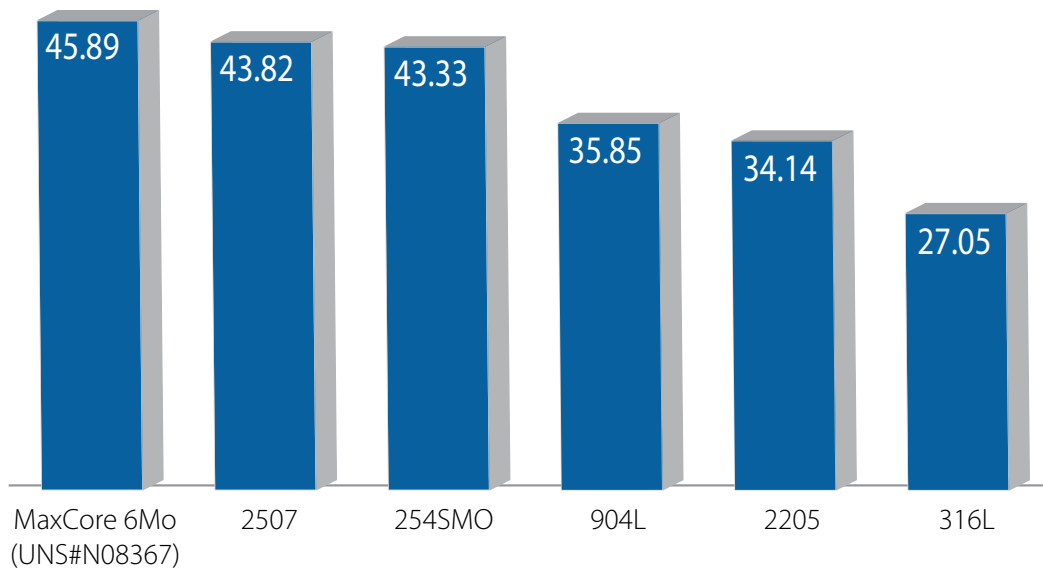

# MaxCore Fittings Specifications

## Product:

MaxCore fittings comply with ASME BPE standards.

Gaskets are made from compounds which are FDA approved and USP 87, 88 Pharmaceutical Class VI certified.

## Sizes:

MaxCore fittings are available in sizes 1/2" - 4" O.D. tube size.

## Material:

Fittings are fabricated in (UNS N08367) (UNS N08904) and (UNS N06022) for superior corrosion resistance.

## Dimensions & Tolerances:

Dimensions as specified in ASME BPE Part DT-3-1

Nominal Size	O.D.		Wall Thickness Mechanical Polish (MP)		Wall Thickness Electropolish (EP)		Squareness Face to Tangent, B		Off Angle, 0		Equivalent Angle (for O)	Off Plane, P		Centerline Radius (CLR), R	
	in.	mm	in.	mm	in.	mm	in.	mm	in.	mm	deg	in.	mm	in.	mm
1/2"	± 0.005	± 0.13	+0.005/-0.008	+0.13/-0.20	+0.005/-0.010	+0.13/-0.25	0.005	0.13	0.014	0.36	1.6	0.030	0.76	1.125	28.58
3/4"	± 0.005	± 0.13	+0.005/-0.008	+0.13/-0.20	+0.005/-0.010	+0.13/-0.25	0.005	0.13	0.018	0.46	1.4	0.030	0.76	1.125	28.58
1"	± 0.005	± 0.13	+0.005/-0.008	+0.13/-0.20	+0.005/-0.010	+0.13/-0.25	0.008	0.20	0.025	0.64	1.4	0.030	0.76	1.500	38.10
1 1/2"	± 0.008	± 0.20	+0.005/-0.008	+0.13/-0.20	+0.005/-0.010	+0.13/-0.25	0.008	0.20	0.034	0.86	1.3	0.050	1.27	2.250	57.15
2"	± 0.008	± 0.20	+0.005/-0.008	+0.13/-0.20	+0.005/-0.010	+0.13/-0.25	0.008	0.20	0.043	1.09	1.2	0.050	1.27	3.000	76.20
2 1/2"	± 0.010	± 0.25	+0.005/-0.008	+0.13/-0.20	+0.005/-0.010	+0.13/-0.25	0.010	0.25	0.054	1.37	1.2	0.050	1.27	3.750	95.25
3"	± 0.010	± 0.25	+0.005/-0.008	+0.13/-0.20	+0.005/-0.010	+0.13/-0.25	0.016	0.41	0.068	1.73	1.3	0.050	1.27	4.500	114.30
4"	± 0.015	± 0.38	+0.008/-0.010	+0.20/-0.25	+0.008/-0.012	+0.20/-0.30	0.016	0.41	0.086	2.18	1.2	0.060	1.52	6.000	152.40

Roundness

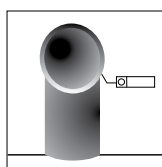

Wall Thickness

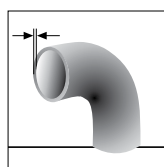

Squareness Face to Tangent

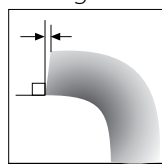

Off Angle

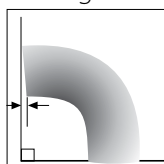

Off Plane

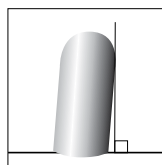

Height

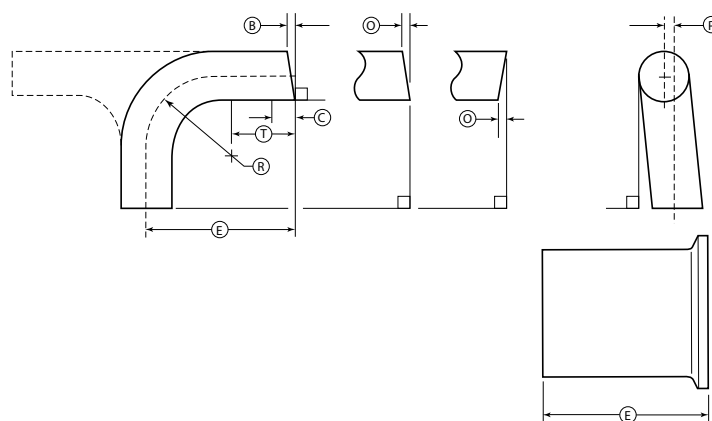
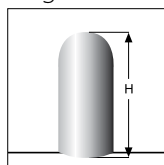

### General Notes:

- Tolerance on (E) end-to-end and center-to-end: 0.050 in. (1.27 mm)
- Tolerance for centerline radius (CLR) is ±10% of the nominal dimension

## Fittings Specifications

### Surface Finish:

Reference: ASME BPE Standard, Part SF.

Surface Finish Code	BPE Surface Designation	Ra Maximum		Inside Surface	Outside Surface
		μ-in.	μm	Surface Condition	Surface Condition
PL	SF1	20	0.51	Mechanically Polished [1]	Mechanically polished to 32 Ra μ-in.
PO	SF5	20	0.51	Mechanically Polished [1] & Electropolished	Mechanically polished to 32 Ra μ-in.

[1] Or any other finishing method that meets the Ra max.

- MaxCore fittings guarantee the Ra (Roughness Average) on all internal surfaces.
- All Ra readings are taken across the lay, wherever possible.
- No single reading shall exceed the Ra max. value.
- Other Ra readings are available if agreed upon between owner/user and supplier.

A multi step cleaning cycle is conducted to ensure that fittings are clean and void of greases and manufacturing fluids.

The cleaning process involves degreasing, pickling, electropolishing and passivation (if required). During the final stage, the fittings are double-rinsed using Deionized water.

### Inspection Procedures:

All fittings produced by EGMO production are 100% visually inspected for compliance with Part SF of the ASME BPE Standard. All dimensional characteristics are inspected for tolerances listed in Part DT of the ASME BPE Standard.

### Fitting Marking Information:

Each fitting and process component is permanently laser marked to show the following:

- Job number
- Heat number/code traceable to material test report for each product contact surface component
- Material type
- Manufacturer's name, logo, & trademark
- Product contact surface designation for the appropriate BPE specification
- ASME BPE mark 



### Packaging & Labeling:

Each fitting is capped, bagged and labeled in full compliance with the ASME BPE standard.

Every label includes a QR Code which directs to the fitting's Material Test Report (Please refer to page 26).

### Documentation:

Full Material Test Reports are supplied with the finished products and are available On-Line at [www.MaxCore.net](http://www.MaxCore.net)



## MaxCore Tube Specifications

### Standards:

- ASME BPE
- Alloy tubing is provided in random lengths 17'-0" minimum to 21'-0" maximum.
- 6Mo Tube complies with ASTM A270/A249/ B676 and ASME SA249/ SB676 (welded), ASTM B690 and ASME SB690 (seamless).
- Alloy 22 Tube complies with ASMEA270/ SB622/ B626 CL 2A/ ASTM B622/B626 CL 2A (welded)

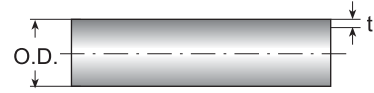

### Surface Finish:

Surface finish specifications are the same for fittings & tubes.

Please refer to page 8 for further information.

### Tubing Dimensional Tolerances

Tubing Diameter		Wall Thickness		OD Tolerance Length (ASTM Spec.)		Length (ASTM Spec.)		Wall Thickness Tolerance
inch	mm.	inch	mm.	inch	mm.	inch	mm.	ASTM Spec.
1/2"	12.70	0.065	1.65	+/- 0.005	+/- 0.129	0.125	3.175	+/- 10%
3/4"	19.05	0.065	1.65	+/- 0.005	+/- 0.130	0.125	3.175	+/- 10%
1"	25.40	0.065	1.65	+/- 0.005	+/- 0.131	0.125	3.175	+/- 10%
1 1/2"	38.10	0.065	1.65	+/- 0.008	+/- 0.203	0.125	3.175	+/- 10%
2"	50.80	0.065	1.65	+/- 0.008	+/- 0.204	0.125	3.175	+/- 10%
2 1/2"	63.50	0.065	1.65	+/- 0.010	+/- 0.254	0.125	3.175	+/- 10%
3"	76.20	0.065	1.65	+/- 0.015	+/- 0.381	0.125	3.175	+/- 10%
4"	101.60	0.083	2.11	+/- 0.015	+/- 0.381	0.188	4.763	+/- 10%

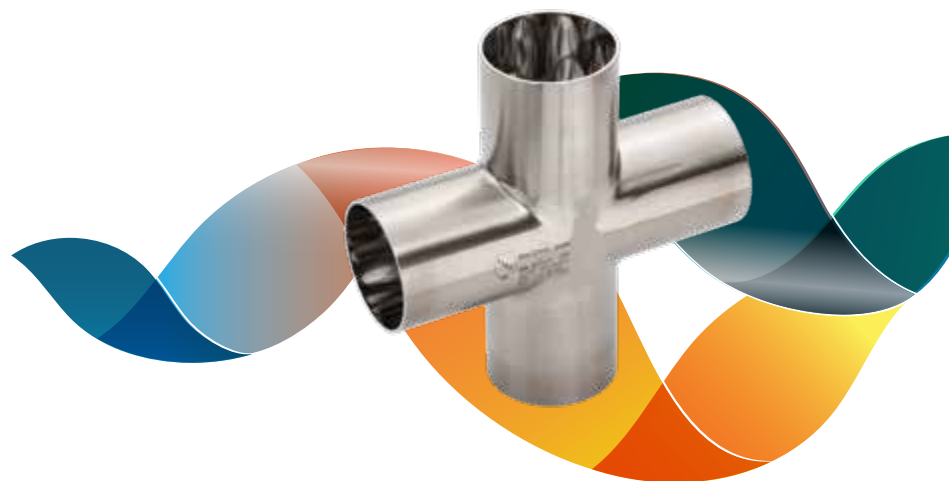

## MaxCore Special Alloys How to Order

To specify the part completely, start with the product description and select the additional options as shown below:

Ordering example (Fitting): 90° weld ends elbow 6Mo Alloy, 1/2" size, PL surface finish

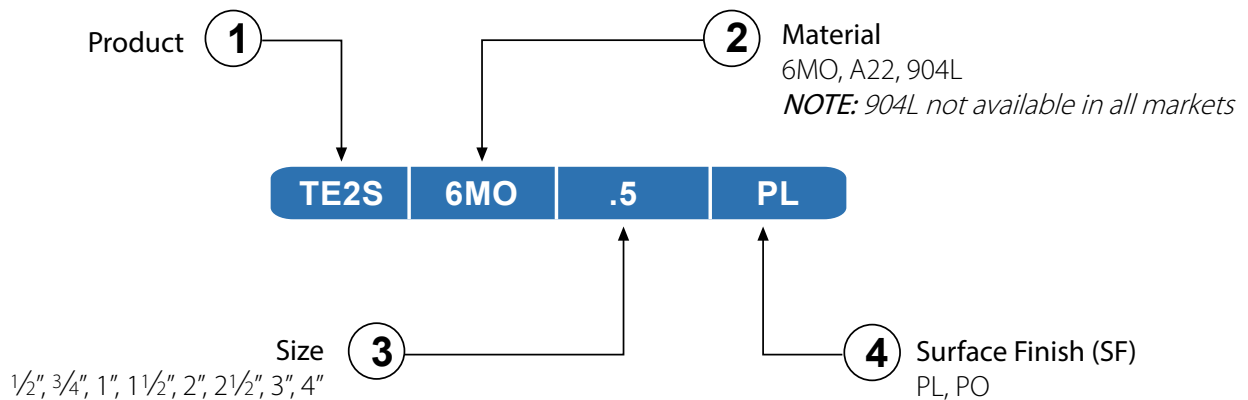

## Ordering Information

Description	Product	Material	Size	Wall Thickness*	Surface finish
Tube	TUBE	6Mo, A22	.5	0.065	PL
Weld Insert Ring A22**	AR22	A22	.75	0.065	PO
90° Weld Elbow	TE2S	6Mo, A22	1	0.065	
90° Elbow Clamp One End	TE2C		1.5	0.065	
90° Elbow Clamp Both Ends	TEG2C		2	0.065	
45° Weld Elbow	TE2KS		2.5	0.065	
45° Elbow Clamp One End	TE2KC		3	0.065	
45° Elbow Clamp Both Ends	TEG2K		4	0.083	
Tee Equal Weld	TE7WWW				
Short Outlet Tee, Weld x Weld X Clamp Outlet	TE7WWCS				
Tee Reducing Weld	TE7RWWW				
Short Outlet Reducing Tee, Weld x Weld X Clamp Outlet	TE7RWWCS				
Instrument Tee, Weld x Weld X Clamp Outlet	TE7IWWCS				
Short Concentric Weld Reducer	TE31SWW				
Short Eccentric Weld Reducer	TE32SWW				
Short Concentric Reducer Clamp Both Ends	TEG31SCC				
Short Eccentric Reducer Clamp Both Ends	TEG32SCC				
Short Concentric Reducer Clamp Large End	TE31SCW				
Short Eccentric Reducer Clamp Large End	TE32SCW				
Clamp Ferrule Short	TEG2CS				
Clamp Ferrule Medium	TEG14BM7				
Clamp Ferrule Long	TEG14AM7				
Solid End Cap	TEG16A				

\* Refers to Tubes

\*\* Surface finishes not applicable on weld insert rings.

## Tubes

### 6Mo / A22 ALLOY TUBING

Size	Part Number	Wall Thickness
1/2"	TUBE6MO.5x.065..	0.065
3/4"	TUBE6MO.75x.065..	0.065
1"	TUBE6MO1.0x.065..	0.065
1 1/2"	TUBE6MO1.5x.065..	0.065
2"	TUBE6MO2.0x.065..	0.065
2 1/2"	TUBE6MO2.5x.065..	0.065
3"	TUBE6MO3.0x.065..	0.065
4"	TUBE6MO4.0x.083..	0.083



## Weld Insert Rings

### WELD INSERT RING A22

Size	Part Number	Material
1/2"	AR22-0.5	A22
3/4"	AR22-0.75	A22
1"	AR22-1.0	A22
1 1/2"	AR22-1.5	A22
2"	AR22-2.0	A22
2 1/2"	AR22-2.5	A22
3"	AR22-3.0	A22
4"	AR22-4.0	A22



## Elbows - 90°

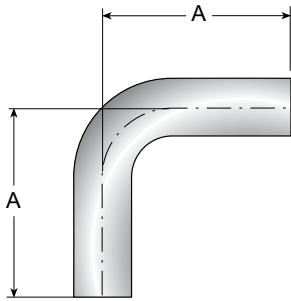

BPE TABLE # DT-4.1.1-1

### TE2S - 90° WELD ELBOW

Size	Dimensions		Part Number
	A in.	A mm	
½"	3.000	76.20	TE2S6MO.5-..
¾"	3.000	76.20	TE2S6MO.75-..
1"	3.000	76.20	TE2S6MO1.0-..
1½"	3.750	95.30	TE2S6MO1.5-..
2"	4.750	120.70	TE2S6MO2.0-..
2½"	5.500	139.70	TE2S6MO2.5-..
3"	6.250	158.80	TE2S6MO3.0-..
4"	8.000	203.20	TE2S6MO4.0-..

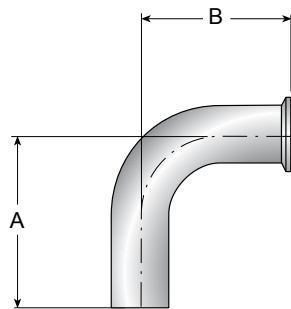

BPE TABLE # DT-4.1.1-2

### TE2C - 90° ELBOW CLAMP ONE END

Size	Dimensions				Part Number
	A in.	A mm	B in.	B mm	
½"	3.000	76.20	1.625	41.30	TE2C6MO.5-..
¾"	3.000	76.20	1.625	41.30	TE2C6MO.75-..
1"	3.000	76.20	2.000	50.80	TE2C6MO1.0-..
1½"	3.750	95.30	2.750	69.90	TE2C6MO1.5-..
2"	4.750	120.70	3.500	88.90	TE2C6MO2.0-..
2½"	5.500	139.70	4.250	108.00	TE2C6MO2.5-..
3"	6.250	158.80	5.000	127.00	TE2C6MO3.0-..
4"	8.000	203.20	6.625	168.30	TE2C6MO4.0-..

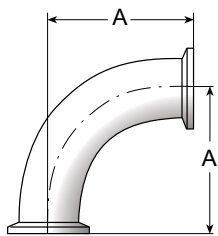

BPE TABLE # DT-4.1.1-3

### TEG2C - 90° CLAMP ELBOW

Size	Dimensions		Part Number
	A in.	A mm	
½"	1.625	41.30	TEG2C6MO.5-..
¾"	1.625	41.30	TEG2C6MO.75-..
1"	2.000	50.80	TEG2C6MO1.0-..
1½"	2.750	69.90	TEG2C6MO1.5-..
2"	3.500	88.90	TEG2C6MO2.0-..
2½"	4.250	108.00	TEG2C6MO2.5-..
3"	5.000	127.00	TEG2C6MO3.0-..
4"	6.625	168.30	TEG2C6MO4.0-..

*Note: Available upon request*

## Elbows - 45°

### TE2KS - 45° WELD ELBOW

Size	Dimensions		Part Number
	A in.	A mm	
½"	2.250	57.2	TE2KS6MO.5-..
¾"	2.250	57.2	TE2KS6MO.75-..
1"	2.250	57.2	TE2KS6MO1.0-..
1½"	2.500	63.5	TE2KS6MO1.5-..
2"	3.000	76.2	TE2KS6MO2.0-..
2½"	3.375	85.7	TE2KS6MO2.5-..
3"	3.625	92.1	TE2KS6MO3.0-..
4"	4.500	114.3	TE2KS6MO4.0-..

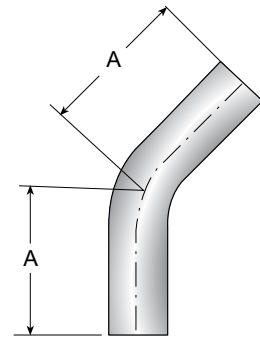

BPE TABLE # DT-4.1.1-4

### TE2KC - 45° ELBOW CLAMP ONE END

Size	Dimensions				Part Number
	A in.	A mm	B in.	B mm	
½"	2.250	57.20	1.000	25.40	TE2KC6MO.5-..
¾"	2.250	57.20	1.000	25.40	TE2KC6MO.75-..
1"	2.250	57.20	1.125	28.60	TE2KC6MO1.0-..
1½"	2.500	63.50	1.438	36.50	TE2KC6MO1.5-..
2"	3.000	76.20	1.750	44.50	TE2KC6MO2.0-..
2½"	3.375	85.70	2.063	52.40	TE2KC6MO2.5-..
3"	3.625	92.10	2.375	60.30	TE2KC6MO3.0-..
4"	4.500	114.30	3.125	79.40	TE2KC6MO4.0-..

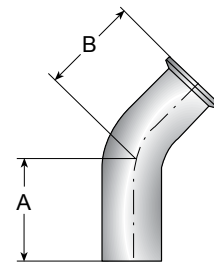

BPE TABLE # DT-4.1.1-5

### TEG2K - 45° CLAMP ELBOW

Size	Dimensions		Part Number
	A in.	A mm	
½"	1.000	25.40	TEG2K6MO.5-..
¾"	1.000	25.40	TEG2K6MO.75-..
1"	1.125	28.60	TEG2K6MO1.0-..
1½"	1.438	36.50	TEG2K6MO1.5-..
2"	1.750	44.50	TEG2K6MO2.0-..
2½"	2.063	52.40	TEG2K6MO2.5-..
3"	2.375	60.30	TEG2K6MO3.0-..
4"	3.125	79.40	TEG2K6MO4.0-..

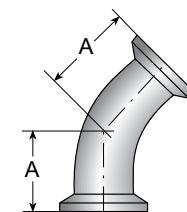

BPE TABLE # DT-4.1.1-6

*Note: Available upon request*

## Tees

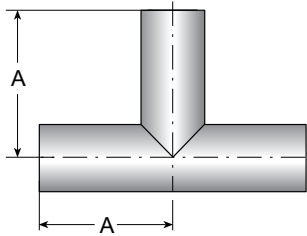

BPE TABLE # DT-4.1.2-1

### TE7WWW - EQUAL TEE

Size	Dimensions		Part Number
	A in.	A mm	
½"	1.875	47.60	TE7WWW6MO.5-..
¾"	2.000	50.80	TE7WWW6MO.75-..
1"	2.125	54.00	TE7WWW6MO1.0-..
1½"	2.375	60.30	TE7WWW6MO1.5-..
2"	2.875	73.00	TE7WWW6MO2.0-..
2½"	3.125	79.40	TE7WWW6MO2.5-..
3"	3.375	85.70	TE7WWW6MO3.0-..
4"	4.125	104.80	TE7WWW6MO4.0-..

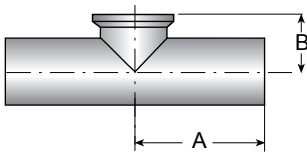

BPE TABLE # DT-4.1.2-2

### TE7WWCS - SHORT OUTLET TEE

Size	Dimensions				Part Number
	A in.	A mm	B in.	B mm	
½"	1.875	47.60	1.000	25.40	TE7WWCS6MO.5-..
¾"	2.000	50.80	1.125	28.60	TE7WWCS6MO.75-..
1"	2.125	54.00	1.125	28.60	TE7WWCS6MO1.0-..
1½"	2.375	60.30	1.375	34.90	TE7WWCS6MO1.5-..
2"	2.875	73.00	1.625	41.30	TE7WWCS6MO2.0-..
2½"	3.125	79.40	1.875	47.60	TE7WWCS6MO2.5-..
3"	3.375	85.70	2.125	54.00	TE7WWCS6MO3.0-..
4"	4.125	104.80	2.750	69.90	TE7WWCS6MO4.0-..

# Tees

## TE7RWWW - TEE REDUCING

Size	Dimensions				Part Number
	A in.	A mm	B in.	B mm	
¾ x ½	2.000	50.80	2.000	50.80	TE7RWWW6MO.75x.5-..
1 x ½	2.125	54.00	2.125	54.00	TE7RWWW6MO1.0x.5-..
1 x ¾	2.125	54.00	2.125	54.00	TE7RWWW6MO1.0x.75-..
1½ x ½	2.375	60.30	2.375	60.30	TE7RWWW6MO1.5x.5-..
1½ x ¾	2.375	60.30	2.375	60.30	TE7RWWW6MO1.5x.75-..
1½ x 1	2.375	60.30	2.375	60.30	TE7RWWW6MO1.5x1.0-..
2 x ½	2.875	73.00	2.625	66.70	TE7RWWW6MO2.0x.5-..
2 x ¾	2.875	73.00	2.625	66.70	TE7RWWW6MO2.0x.75-..
2 x 1	2.875	73.00	2.625	66.70	TE7RWWW6MO2.0x1.0-..
2 x 1½	2.875	73.00	2.625	66.70	TE7RWWW6MO2.0x1.5-..
2½ x 1	3.125	79.40	2.875	73.00	TE7RWWW6MO2.5x1.0-..
2½ x 1½	3.125	79.40	2.875	73.00	TE7RWWW6MO2.5x1.5-..
2½ x 2	3.125	79.40	2.875	73.00	TE7RWWW6MO2.5x2.0-..
3 x ½	3.375	85.70	3.125	79.40	TE7RWWW6MO3.0x.5-..
3 x ¾	3.375	85.70	3.125	79.40	TE7RWWW6MO3.0x.75-..
3 x 1	3.375	85.70	3.125	79.40	TE7RWWW6MO3.0x1.0-..
3 x 1½	3.375	85.70	3.125	79.40	TE7RWWW6MO3.0x1.5-..
3 x 2	3.375	85.70	3.125	79.40	TE7RWWW6MO3.0x2.0-..
3 x 2½	3.375	85.70	3.125	79.40	TE7RWWW6MO3.0x2.5-..
4 x 1	4.125	104.80	3.625	92.10	TE7RWWW6MO4.0x1.0-..
4 x 1½	4.125	104.80	3.625	92.10	TE7RWWW6MO4.0x1.5-..
4 x 2	4.125	104.80	3.875	98.40	TE7RWWW6MO4.0x2.0-..
4 x 3	4.125	104.80	3.875	98.40	TE7RWWW6MO4.0x3.0-..

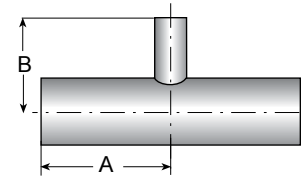

BPE TABLE # DT-4.1.2-6

## TE7RWWCS - SHORT OUTLET REDUCING TEE

Size	Dimensions				Part Number
	A in.	A mm	B in.	B mm	
¾ x ½	2.000	50.80	1.000	25.40	TE7RWWCS6MO.75x.5-..
1 x ½	2.125	54.00	1.125	28.60	TE7RWWCS6MO1.0x.5-..
1 x ¾	2.125	54.00	1.125	28.60	TE7RWWCS6MO1.0x.75-..
1½ x ½	2.375	60.30	1.375	34.90	TE7RWWCS6MO1.5x.5-..
1½ x ¾	2.375	60.30	1.375	34.90	TE7RWWCS6MO1.5x.75-..
1½ x 1	2.375	60.30	1.375	34.90	TE7RWWCS6MO1.5x1.0-..
2 x ½	2.875	73.00	1.625	41.30	TE7RWWCS6MO2.0x.5-..
2 x ¾	2.875	73.00	1.625	41.30	TE7RWWCS6MO2.0x.75-..
2 x 1	2.875	73.00	1.625	41.30	TE7RWWCS6MO2.0x1.0-..
2 x 1½	2.875	73.00	1.625	41.30	TE7RWWCS6MO2.0x1.5-..
2½ x 1	3.125	79.40	1.875	47.60	TE7RWWCS6MO2.5x1.0-..
2½ x 1½	3.125	79.40	1.875	47.60	TE7RWWCS6MO2.5x1.5-..
2½ x 2	3.125	79.40	1.875	47.60	TE7RWWCS6MO2.5x2.0-..
3 x ½	3.375	85.70	2.125	54.00	TE7RWWCS6MO3.0x.5-..
3 x ¾	3.375	85.70	2.125	54.00	TE7RWWCS6MO3.0x.75-..
3 x 1	3.375	85.70	2.125	54.00	TE7RWWCS6MO3.0x1.0-..
3 x 1½	3.375	85.70	2.125	54.00	TE7RWWCS6MO3.0x1.5-..
3 x 2	3.375	85.70	2.125	54.00	TE7RWWCS6MO3.0x2.0-..
4 x ½	4.125	104.80	2.625	66.70	TE7RWWCS6MO4.0x.5-..
4 x ¾	4.125	104.80	2.625	66.70	TE7RWWCS6MO4.0x.75-..
4 x 1	4.125	104.80	2.625	66.70	TE7RWWCS6MO4.0x1.0-..
4 x 1½	4.125	104.80	2.625	66.70	TE7RWWCS6MO4.0x1.5-..
4 x 2	4.125	104.80	2.625	66.70	TE7RWWCS6MO4.0x2.0-..
4 x 2½	4.125	104.80	2.625	66.70	TE7RWWCS6MO4.0x2.5-..
4 x 3	4.125	104.80	2.625	66.70	TE7RWWCS6MO4.0x3.0-..

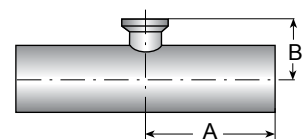

BPE TABLE # DT-4.1.2-7

## Tees

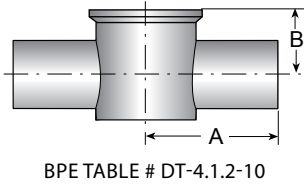

### TE7IWWCS - INSTRUMENT TEE

Size	Dimensions				Part Number
	A in.	A mm	B in.	B mm	
1/2 x 1 1/2	2.500	63.50	0.875	22.20	TE7IWWCS6MO.5x1.5-..
1/2 x 2	2.500	63.50	1.000	25.40	TE7IWWCS6MO.5x2.0-..
3/4 x 1 1/2	2.500	63.50	1.125	28.60	TE7IWWCS6MO.75x1.5-..
3/4 x 2	2.750	69.90	1.000	25.40	TE7IWWCS6MO.75x2.0-..
1 x 1 1/2	2.750	69.90	1.125	28.60	TE7IWWCS6MO1.0x1.5-..
1 x 2	2.750	69.90	1.250	31.80	TE7IWWCS6MO1.0x2.0-..
1 1/2 x 2	2.750	69.90	1.500	38.10	TE7IWWCS6MO1.5x2.0-..

*Note: Available upon request*





## Reducers

### TE31SWW - SHORT CONCENTRIC REDUCER

Size	Dimensions						Part Number
	A In.	A mm.	L3 In.	L3 mm.	L4 In.	L4 mm.	
¾ x ½	2.125	53.97	1.000	25.4	1.000	25.40	TE31SWW6MO.75x.5-..
1 x ½	2.500	63.50	1.000	25.4	1.000	25.40	TE31SWW6MO1.0x.5-..
1 x ¾	2.125	53.97	1.000	25.4	1.000	25.40	TE31SWW6MO1.0x.75-..
1½ x ¾	3.000	76.20	1.000	25.4	1.000	25.40	TE31SWW6MO1.5x.75-..
1½ x 1	2.500	63.50	1.000	25.4	1.000	25.40	TE31SWW6MO1.5x1.0-..
2 x 1	3.375	85.72	1.000	25.4	1.000	25.40	TE31SWW6MO2.0x1.0-..
2 x 1½	2.500	63.50	1.000	25.4	1.000	25.40	TE31SWW6MO2.0x1.5-..
2½ x 1½	3.375	85.72	1.000	25.4	1.000	25.40	TE31SWW6MO2.5x1.5-..
2½ x 2	2.500	63.50	1.000	25.4	1.000	25.40	TE31SWW6MO2.5x2.0..
3 x 1½	4.250	107.95	1.000	25.4	1.500	38.10	TE31SWW6MO3.0x1.5-..
3 x 2	3.375	85.72	1.000	25.4	1.500	38.10	TE31SWW6MO3.0x2.0-..
3 x 2½	2.625	66.67	1.000	25.4	1.500	38.10	TE31SWW6MO3.0x2.5-..
4 x 2	5.125	130.17	1.000	25.4	1.500	38.10	TE31SWW6MO4.0x2.0-..
4 x 2½	4.250	107.95	1.000	25.4	1.500	38.10	TE31SWW6MO4.0x2.5-..
4 x 3	3.875	98.42	1.500	38.1	1.500	38.10	TE31SWW6MO4.0x3.0-..

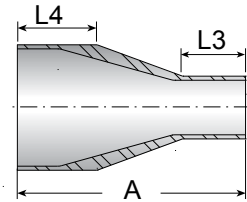

BPE TABLE # DT-4.1.3-1

### TE31SCW - SHORT CONCENTRIC REDUCER ONE CLAMP

Size	Dimensions				Part Number
	A In.	A mm.	L3 In.	L3 mm.	
¾ x ½	2.625	66.67	1.000	25.40	TE31SCW6MO.75x.5-..
1 x ½	3.000	76.20	1.000	25.40	TE31SCW6MO1.0x.5-..
1 x ¾	2.625	66.67	1.000	25.40	TE31SCW6MO1.0x.75-..
1½ x ¾	3.500	88.90	1.000	25.40	TE31SCW6MO1.5x.75-..
1½ x 1	3.000	76.20	1.000	25.40	TE31SCW6MO1.5x1.0-..
2 x 1	3.875	98.42	1.000	25.40	TE31SCW6MO2.0x1.0-..
2 x 1½	3.000	76.20	1.000	25.40	TE31SCW6MO2.0x1.5-..
2½ x 1½	3.875	98.42	1.000	25.40	TE31SCW6MO2.5x1.5-..
2½ x 2	3.000	76.20	1.000	25.40	TE31SCW6MO2.5x2.0..
3 x 2	3.875	98.42	1.000	25.40	TE31SCW6MO3.0x2.0-..
3 x 2½	3.125	79.37	1.000	25.40	TE31SCW6MO3.0x2.5-..
4 x 2½	4.875	123.82	1.000	25.40	TE31SCW6MO4.0x2.5-..
4 x 3	4.500	114.30	1.500	38.10	TE31SCW6MO4.0x3.0-..

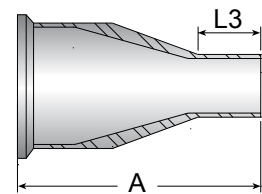

BPE TABLE # DT-4.1.3-2

*Note: Available upon request*

## Reducers

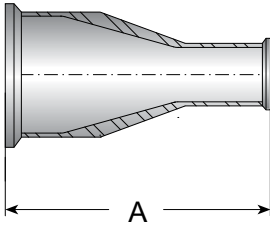

BPE TABLE # DT-4.1.3-3

### TEG31SCC - SHORT CONCENTRIC REDUCER CLAMP

Size	Dimensions		Part Number
	A In.	A mm.	
¾ x ½	3.125	79.37	TEG31SCC6MO.75x.5-..
1 x ½	3.500	88.90	TEG31SCC6MO1.0x.5-..
1 x ¾	3.125	79.37	TEG31SCC6MO1.0x.75-..
1½ x ¾	4.000	101.60	TEG31SCC6MO1.5x.75-..
1½ x 1	3.500	88.90	TEG31SCC6MO1.5x1.0-..
2 x 1	4.375	111.13	TEG31SCC6MO2.0x1.0-..
2 x 1½	3.500	88.90	TEG31SCC6MO2.0x1.5-..
2½ x 2	3.500	88.90	TEG31SCC6MO2.5x2.0-..
3 x 1½	5.250	133.35	TEG31SCC6MO3.0x1.5-..
3 x 2	4.375	111.12	TEG31SCC6MO3.0x2.0-..
3 x 2½	3.625	92.07	TEG31SCC6MO3.0x2.5-..
4 x 3	5.000	127.00	TEG31SCC6MO4.0x3.0-..

*Note: Available upon request*

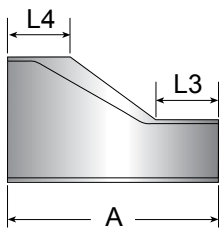

BPE TABLE # DT-4.1.3-1

### TE32SWW - SHORT ECCENTRIC REDUCER

Size	Dimensions						Part Number
	A In.	A mm.	L3 In.	L3 mm.	L4 In.	L4 mm.	
¾ x ½	2.125	53.97	1.000	25.40	1.000	25.40	TE32SWW6MO.75x.5-..
1 x ½	2.500	63.50	1.000	25.40	1.000	25.40	TE32SWW6MO1.0x.5-..
1 x ¾	2.125	53.97	1.000	25.40	1.000	25.40	TE32SWW6MO1.0x.75-..
1½ x ¾	3.000	76.20	1.000	25.40	1.000	25.40	TE32SWW6MO1.5x.75-..
1½ x 1	2.500	63.50	1.000	25.40	1.000	25.40	TE32SWW6MO1.5x1.0-..
2 x 1	3.375	85.72	1.000	25.40	1.000	25.40	TE32SWW6MO2.0x1.0-..
2 x 1½	2.500	63.50	1.000	25.40	1.000	25.40	TE32SWW6MO2.0x1.5-..
2½ x 1½	3.375	85.72	1.000	25.40	1.000	25.40	TE32SWW6MO2.5x1.5-..
2½ x 2	2.500	63.50	1.000	25.40	1.000	25.40	TE32SWW6MO2.5x2.0-..
3 x 1½	4.250	107.95	1.000	25.40	1.500	38.10	TE32SWW6MO3.0x1.5-..
3 x 2	3.375	85.72	1.000	25.40	1.500	38.10	TE32SWW6MO3.0x2.0-..
3 x 2½	2.625	66.67	1.000	25.40	1.500	38.10	TE32SWW6MO3.0x2.5-..
4 x 2	5.125	130.17	1.000	25.40	1.500	38.10	TE32SWW6MO4.0x2.0-..
4 x 2½	4.250	107.95	1.000	25.40	1.500	38.10	TE32SWW6MO4.0x2.5-..
4 x 3	3.875	98.42	1.500	38.10	1.500	38.10	TE32SWW6MO4.0x3.0-..

## Reducers

### TEG32SCC - SHORT ECCENTRIC REDUCER CLAMP

Size	Dimensions		Part Number
	A In.	A mm.	
¾ x ½	3.125	79.37	TEG32SCC6MO.75x.5-..
1 x ½	3.500	88.90	TEG32SCC6MO1.0x.5-..
1 x ¾	3.125	79.37	TEG32SCC6MO1.0x.75-..
1½ x ¾	4.000	101.60	TEG32SCC6MO1.5x.75-..
1½ x 1	3.500	88.90	TEG32SCC6MO1.5x1.0-..
2 x 1	4.375	111.12	TEG32SCC6MO2.0x1.0-..
2 x 1½	3.500	88.90	TEG32SCC6MO2.0x1.5-..
3 x 2	4.375	111.12	TEG32SCC6MO3.0x2.0-..
3 x 2½	3.625	92.07	TEG32SCC6MO3.0x2.5-..
4 x 2	6.250	158.75	TEG32SCC6MO4.0x2.0-..
4 x 3	5.000	127.00	TEG32SCC6MO4.0x3.0-..

*Note: Available upon request*

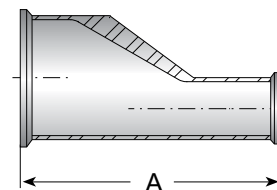

BPE TABLE # DT-4.1.3-3

### TE32SCW - SHORT ECCENTRIC REDUCER ONE CLAMP

Size	Dimensions				Part Number
	A In.	A mm.	L3 In.	L3 mm.	
¾ x ½	2.625	66.67	1.000	25.40	TE32SCW6MO.75x.5-..
1 x ½	3.000	76.20	1.000	25.40	TE32SCW6MO1.0x.5-..
1 x ¾	2.625	66.67	1.000	25.40	TE32SCW6MO1.0x.75-..
1½ x ¾	3.500	88.90	1.000	25.40	TE32SCW6MO1.5x.75-..
1½ x 1	3.000	76.20	1.000	25.40	TE32SCW6MO1.5x1.0-..
2 x 1	3.875	98.42	1.000	25.40	TE32SCW6MO2.0x1.0-..
2 x 1½	3.000	76.20	1.000	25.40	TE32SCW6MO2.0x1.5-..
2½ x 1½	3.875	98.42	1.000	25.40	TE32SCW6MO2.5x1.5-..
2½ x 2	3.000	76.20	1.000	25.40	TE32SCW6MO2.5x2.0-..
3 x 2	3.875	98.42	1.000	25.40	TE32SCW6MO3.0x2.0-..
3 x 2½	3.125	79.37	1.000	25.40	TE32SCW6MO3.0x2.5-..
4 x 2	5.750	146.05	1.000	25.40	TE32SCW6MO4.0x2.0-..
4 x 3	4.500	114.30	1.500	38.10	TE32SCW6MO4.0x3.0-..

*Note: Available upon request*

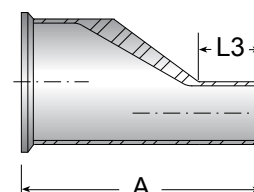

BPE TABLE # DT-4.1.3-2

## Ferrules

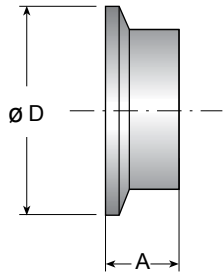

BPE TABLE # DT-4.1.4-1(C)

### TEG2CS - CLAMP FERRULE SHORT

Size	Dimensions				Part Number
	A in.	A mm	D in.	D mm	
½"	0.500	12.70	0.984	24.90	TEG2CS6MO.5-..
¾"	0.500	12.70	0.984	24.90	TEG2CS6MO.75-..
1"	0.500	12.70	1.984	50.30	TEG2CS6MO1.0-..
1½"	0.500	12.70	1.984	50.30	TEG2CS6MO1.5-..
2"	0.500	12.70	2.516	63.90	TEG2CS6MO2.0-..
2½"	0.500	12.70	3.047	77.30	TEG2CS6MO2.5-..
3"	0.500	12.70	3.579	90.90	TEG2CS6MO3.0-..
4"	0.625	15.90	4.682	118.90	TEG2CS6MO4.0-..

*Note: Available upon request*

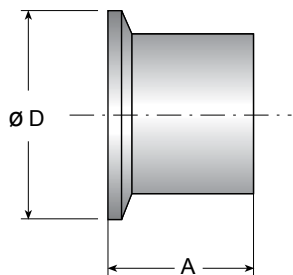

BPE TABLE # DT-4.1.4-1(B)

### TEG14BM7 - CLAMP FERRULE MEDIUM

Size	Dimensions				Part Number
	A in.	A mm	D in.	D mm	
½"	1.130	28.70	0.984	24.90	TEG14BM76MO.5-..
¾"	1.130	28.70	0.984	24.90	TEG14BM76MO.75-..
1"	1.130	28.70	1.984	50.30	TEG14BM76MO1.0-..
1½"	1.130	28.70	1.984	50.30	TEG14BM76MO1.5-..
2"	1.130	28.70	2.516	63.90	TEG14BM76MO2.0-..
2½"	1.130	28.70	3.047	77.30	TEG14BM76MO2.5-..
3"	1.130	28.70	3.579	90.90	TEG14BM76MO3.0-..
4"	1.130	28.70	4.682	118.90	TEG14BM76MO4.0-..

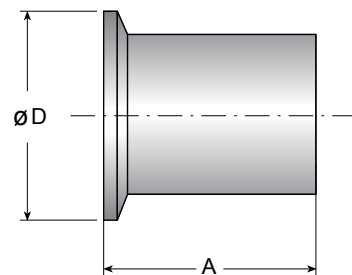

BPE TABLE # DT-4.1.4-1(A)

### TEG14AM7 - CLAMP FERRULE LONG

Size	Dimensions				Part Number
	A in.	A mm	D in.	D mm	
½"	1.750	44.50	0.984	24.90	TEG14AM76MO.5-..
¾"	1.750	44.50	0.984	24.90	TEG14AM76MO.75-..
1"	1.750	44.50	1.984	50.30	TEG14AM76MO1.0-..
1½"	1.750	44.50	1.984	50.30	TEG14AM76MO1.5-..
2"	2.250	57.20	2.516	63.90	TEG14AM76MO2.0-..
2½"	2.250	57.20	3.047	77.30	TEG14AM76MO2.5-..
3"	2.250	57.20	3.579	90.90	TEG14AM76MO3.0-..
4"	2.250	57.20	4.682	118.90	TEG14AM76MO4.0-..

*Note: Available upon request*

## Solid End Caps

### TEG16A - SOLID END CAP

Size	Dimensions				Part Number
	A in.	A mm	D in.	D mm	
½" - ¾"	0.187	4.70	0.984	24.90	TEG16A6MO.75-..
1" - 1½"	0.250	6.40	1.984	50.30	TEG16A6MO1.5-..
2"	0.250	6.40	2.516	63.90	TEG16A6MO2.0-..
2½"	0.250	6.40	3.047	77.30	TEG16A6MO2.5-..
3"	0.250	6.40	3.579	90.90	TEG16A6MO3.0-..
4"	0.312	7.90	4.682	118.90	TEG16A6MO4.0-..

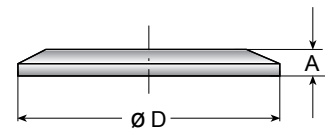

BPE TABLE # DT-4.1.5-2

## 6Mo Welding Considerations

Special consideration should be given to alloys containing 6% molybdenum content. Those alloys identified in this publication are MaxCore 6Mo (UNS #N08367) and Ultra 6XN® (UNS #N08367). In order to compensate for alloy dilution within the weld during the cooling phase, it is recommended the welds be “over-alloyed” with the addition of a weld insert ring or weld wire. The recommended choice for over alloying 6Mo welds is alloy 22. Table below indicates acceptable filler metals for use with 6Mo materials.

The acceptable arc welding processes for 6Mo products are:

- GTAW - Gas Tungsten Arc Welding
- GMAW- Gas Metal Arc Welding
- SMAW- Shielded Metal Arc Welding
- FCAW- Flux Cored Arc Welding
- SAW- Submerged Arc Welding
- Autogenous Welding

Welding Process	Consumables				
	Filler Metal	Specifications		Classifications	
	Alloy	AWS	ASME	AWS	UNS
GTAW	625			ERNiCrMo-3	N06625
	276	A5.14	SFA5.14	ERNiCrMo-4	N10276
	22			ERNiCrMo-10	N06022
GMAW	625			ERNiCrMo-3	N06625
	276	A5.14	SFA5.14	ERNiCrMo-4	N10276
	22			ERNiCrMo-10	N06022
SMAW	112			ERNiCrMo-3	W86112
	276	A5.11	SFA5.11	ERNiCrMo-4	W80276
	22			ERNiCrMo-10	W86022

Inert Gas should be used for both the shielding and purge gas. In order to eliminate nitrides forming on the surface resulting in a straw color on the welds, it is recommended to use 100% argon for both purge and backing gases.

## General Technical Information

### Pressure service ratings for sanitary stainless steel clamps

Size Tube OD	13MHHM(-H)				13MHHS				13MHP			
	@70°F / 21°C		@250°F / 121°C		@70°F / 21°C		@250°F / 121°C		@70°F / 21°C		@250°F / 121°C	
	PSI	bar	PSI	bar	PSI	bar	PSI	bar	PSI	bar	PSI	bar
1/2 & 3/4"	1500	103	1200	83	-	-	-	-	1500	103	1200	83
1 & 1 1/2"	500	34	250	17	600	41	300	21	1500	103	1200	83
2"	450	31	250	17	550	38	275	19	1000	69	800	55
2 1/2"	400	28	200	14	450	31	225	16	1000	69	800	55
3"	350	24	150	10	350	24	160	11	1000	69	800	55
4"	200	14	125	9	250	17	150	10	1000	69	800	55
5"	175	12	100	7	-	-	-	-	-	-	-	-
6"	150	10	75	5	-	-	-	-	-	-	-	-
8"	100	7	50	3	-	-	-	-	-	-	-	-
10"	40	3	30	2	-	-	-	-	-	-	-	-
12"	30	2	25	2	-	-	-	-	-	-	-	-

*Note: The pressure information doesn't refer to the gaskets.*

### Gasket Material Properties

Property	PTFE®	VITON®	SILICON	EPDM
Temperature Range	-40 to 450° F -40 to 232° C	-20 to 400° F -29 to 204° C	-80 to 450° F -62 to 232° C	-55 to 275° F -48 to 135° C
Acid Resistance	Excellent	Good	Good	Good - excellent
Alkali Resistance	Excellent	Poor - good	Poor - fair	Good - excellent
Abrasion Resistance	Excellent	Good	Good - excellent	Good - excellent
Compression Set	Cold flows	Good - excellent	Good - excellent	Fair

### Conversion Table Of Surface Finishes

Mechanical Finish		
μ-in.	μm	Grit
32 Ra	0.8 Ra	150
24 Ra	0.6 Ra	180
20 Ra	0.5 Ra	240
12 Ra	0.3 Ra	320

Available upon request in Special Alloys (Not available in all markets)

Bio-Connect



Connect S



Ball Valves



Single Seat Valves



Double Seat Valves



Butterfly Valves



Check Valves





Diaphragm Valves



Sampling Valves



Specials

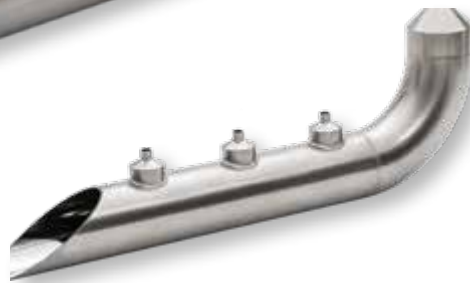

## MTR - Material Test Report

The MTR is the reference document for the entire history of the production processes and the raw materials used to make the MaxCore 6Mo component.

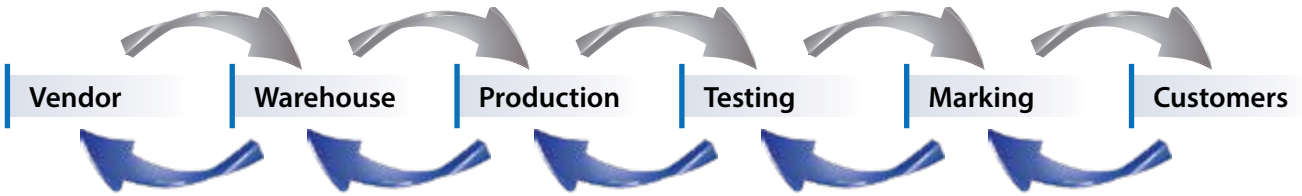

The MTR document is easily generated on-line via [www.Max-Core.com](http://www.Max-Core.com) using only the job number as input.

The job number is the product identification number which represents all processes and raw materials related to the specific item.

### On-Line MTR

Please, enter job/certificate number:

[CREATE CERTIFICATE >](#)



The MTR is also available for download with QR CODE

The MTR format provides the following information:

- Part number, part description and job number
- Material type
- Heat Number per each component describing the fitting and its associated properties:
  - Tube dimensions and standards
  - Chemical composition
  - Mechanical properties
  - Visual, dimensional, corrosion, EDDY current testing, flaring and flattening, PMI Test
- Certificate of Compliance

# ASME BPE - Certificate



**BPE**

## CERTIFICATE OF AUTHORIZATION

The named company is authorized by the American Society of Mechanical Engineers (ASME) for the scope shown below in accordance with the applicable rules of the ASME BPE Standard on Bioprocessing Equipment. The use of the certification mark and the authority granted by this Certificate of Authorization are subject to the provisions of the agreement set forth in the application. Any component certified under this authorization shall have been produced, assembled, and tested in accordance with the provisions of the aforementioned ASME standard.

COMPANY:

**EGMO Ltd.  
MaxPure  
1 Hayotsrim St.  
Nahariya 22110  
Israel**

SCOPE:

**Manufacture of ferrous and nonferrous fittings at the above location only**

AUTHORIZED: **May 1, 2018**  
EXPIRES: **May 21, 2023**  
CERTIFICATE NUMBER: **BPE-102**

**The American Society of Mechanical Engineers**



  
Vice President, Conformity Assessment

  
Managing Director, Conformity Assessment

# NEUMO EHRENBERG GROUP

## GLOBAL LOCATIONS



### NEUMO GmbH+Co. KG (D)

Tel: +49 (0) 7043 36 0  
Fax: +49 (0) 7043 36 179  
E-Mail: info@neumo.de  
www.neumo.de  
**GERMANY**



### VNE Corporation

Tel: +1 800 356 1111  
+1 608 756 4930  
Fax: +1 608 756 3643  
E-Mail: stainless@vnecorp.com  
www.vnestainless.com  
**U.S.A**



### EGMO Ltd.

Tel: +972 (0) 4 9855 176  
+972 (0) 4 9855 111  
Fax: +972 (0) 4 9855 175  
E-Mail: salese@egmo.co.il  
www.egmo.co.il  
**ISRAEL**



### NEUMO-EGMO Spain S.L

Tel: +34 977 524 914  
Fax: +34 977 524 898  
E-Mail: neumo-es@neumo-es.com  
www.neumo-es.com  
**SPAIN**



### HPT Inc.

Tel: +845.452.1103  
+800.284.4478  
E-Mail: sales@hptinc.com  
http://www.hptinc.com/  
**U.S.A**



### Herrli AG

Tel: +41 (0) 31 750 12 11  
Fax: +41 (0) 31 750 12 00  
E-Mail: info@herrli.net  
www.herrli.net  
**SWITZERLAND**



### NEUMO Polska Sp. z.o.o

Tel: +48 (0) 46 833 4306  
Fax: +48 (0) 46 832 5626  
E-Mail: neumo@neumo.pl  
**POLAND**



### NEUMO Turkey

Tel: +90 (212) 875 01 41  
Fax: +90 (212) 875 23 13  
E-Mail: info@neumo.com.tr  
www.neumo.com.tr  
**TURKEY**



### NEUMO Budapest Kft

Tel: +36 (1) 3174177  
+36 (1) 3185982  
Fax: +36 (1) 266 8765  
E-Mail: neumo@neumo.hu  
www.neumo.hu  
**HUNGARY**



### NEUMO LLC

Tel: +84 908475382  
E-Mail: Minh.Vietnam@neumo.de  
www.awh.eu  
**VIETNAM**



### NEUMO - VARGUS (Shanghai)

Trading Co., Ltd  
Tel: +86 (21) 51688300  
Fax: +86 (21) 51688380  
E - Mail: info@neumo.com.cn  
**CHINA**



### NEUMO UK Ltd.

Tel: +44 (0) 1952 583 999  
Fax: +44 (0) 1952 583 958  
E-Mail: stainless@neumo.co.uk  
www.neumo.co.uk  
**UNITED KINGDOM**



### AWH Armaturenwerke (D)

Hötensleben GmbH  
Tel: +49 (0) 39405 92 0  
Fax: +49 (0) 39405 92 111  
E-Mail: info@awh.de  
www.awh.de

### Damstahl GmbH (D)

Tel: +49 (0) 2173 797 0  
Fax: +49 (0) 2173 797 274  
E-Mail: ds@damstahl.de  
www.damstahl.de

### Gebr. Rieger GmbH+Co. KG (D)

Tel: +49 (0) 7361 5702 0  
Fax: +49 (0) 7361 5702 51  
E-Mail: info@rr-rieger.de  
www.rr-rieger.de  
**GERMANY**



### NEUMO

Tel: +353 (0)21 4975540  
Cel: +353 (0)87 2330469  
E-Mail: dosullivan@neumo.de  
www.neumo.de/en/  
**IRELAND**



### Damstahl a/s (Denmark)

Tel: +45 (0) 8794 4000  
Fax: +45 (0) 8794 4150  
E-Mail: ds@damstahl.com  
www.damstahl.dk  
**DENMARK**



### Damstahl a/s Oslo (N)

Tel: +47 5615 1570  
Fax: +47 5615 1571  
E-Mail: dano@damstahl.com  
www.damstahl.no  
**NORWAY**



### Damstahl a/b (Sweden)

Tel: +46 87 61 71 00  
Fax: +46 87 61 14 05  
www.damstahl.se  
**SWEDEN**

